

**DURAKOOL**

A WT/AEC Brand

# DZ Sockets for Automotive Relays

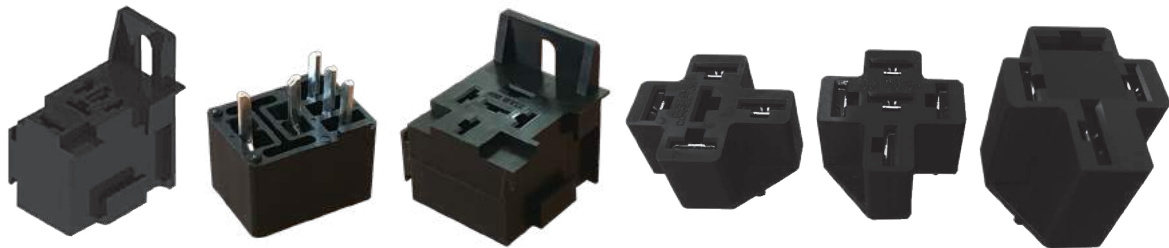



## Durakool

Durakool, a WT/AEC Brand, has a long history, some 90 years, in the manufacturing of specialized, highly engineered, electrical and electronic components, primarily for automotive and industrial applications.

This catalogue gives detailed information of our current specialized DZ automotive sockets, designed to fit Durakool automotive relays.

Durakool's unique range of miniature automotive relays and HVDC contactors are specially designed for applications up to 1000VDC, together with high current switching of DC loads. Specialist contactors can switch more than 3000A up to 72VDC and our miniature automotive Micro, Mini and Maxi ISO style HVDC relays fit industry standard relay sockets and terminals.

Through our disciplined approach, we have earned an excellent reputation for our technical innovation, agility, rapid response and high reliability. Our Team has a "CAN DO" attitude and is ready to tackle your most challenging applications.

Our creative engineering team has extensive experience in harsh environmental packaging concepts. We use high quality products and make our own glass to metal hermetic seals.

Please contact our Engineering Team at Willow Technologies Limited, AEC, or your local distributor for further information and non standard items from within our extensive product range.

## Controlling electricity for over 80 years!

- ▲ Global production facilities
- ▲ Extensive product portfolio
- ▲ Reputation for high reliability
- ▲ ISO9001:2008 & ISO14001:2004 Registered



## Index of Contents

Index of Contents		Page
Durakool	Company information	2
Index	Catalogue contents	3
<b>Part Number</b>	<b>Use with relay series</b>	-
<b>DZ82AB-4-PCB</b>	DG82	4
<b>DZ82AB-5-PCB</b>	DG82	4
<b>DZ82AB-4-SPCB</b>	DG82	4
<b>DZ82AB-5-SPCB</b>	DG82	5
<b>DZ82AB-5-WH1</b>	DG82	5
<b>DZ82AB-5-WH2</b>	DG82	5
<b>DZ85AB-4-WH</b>	DG55, DG56A, DG57BM, DG85A, DG85B, DG85BM, DG85F	6
<b>DZ85AB-5-WH</b>	DG55, DG55M, DG56A, DG57BM, DG85A, DG85B, DG85BM, DG85F	6
<b>DZ85AB-5-WH1</b>	DG55, DG55M, DG56A, DG57BM, DG85A, DG85B, DG85BM, DG85F	6
<b>DZ85AB-5-WH2</b>	DG55, DG55M, DG56A, DG57BM, DG85A, DG85B, DG85BM, DG85F	7
<b>DZ85AB-4-PCB</b>	DG55, DG56A, DG57BM, DG85A, DG85B, DG85BM, DG85F	7
<b>DZ85AB-4-SPCB</b>	DG55, DG56A, DG57BM, DG85A, DG85B, DG85BM, DG85F	7
<b>DZ85AB-5-PCB</b>	DG55, DG55M, DG56A, DG57BM, DG85A, DG85B, DG85BM, DG85F	8
<b>DZ85AB-5-SPCB</b>	DG55, DG55M, DG56A, DG57BM, DG85A, DG85B, DG85BM, DG85F	8
<b>DZ85CD-4-SPCB</b>	DG56C, DG57CM, DG85C, DG85G	8
<b>DZ85CD-4-WH</b>	DG56C, DG57CM, DG85C, DG85D, DG85G, DG85H	9
<b>DZ85CD-5-WH</b>	DG56C, DG85C, DG85G	9
<b>DZ85AB-5-WP</b>	DG56A, DG85A, DG85B & DG85F with skirt option "S" or "S1"	9
<b>DZ85S-O</b>	Cable seal, fits DZ85AB-5-WP	10
<b>DZ85S-G</b>	Cable seal, fits DZ85AB-5-WP	10
<b>DZ85S-Y</b>	Cable seal, fits DZ85AB-5-WP	10
<b>DZ85P-G</b>	Blanking plug, fits DZ85AB-5-WP	10
<b>Back Cover</b>	Catalogue Issue Number	11

### DZ82AB-4-PCB - 4 Pin PCB socket for micro-ISO relays



- Brass, bright tin (Sn) plated contacts
- Heat stabilised thermoplastic, 140°C
- Continuous use temperature rating
- 4 Pin
- PCB Mount
- RoHS Compliant

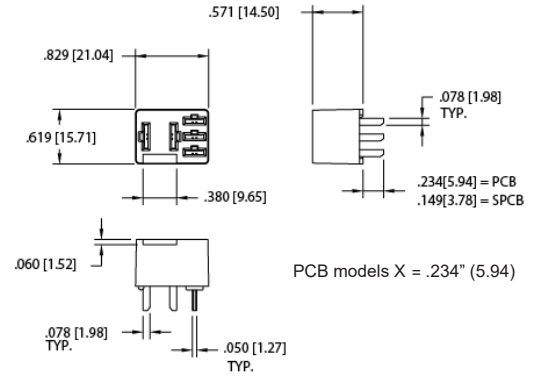
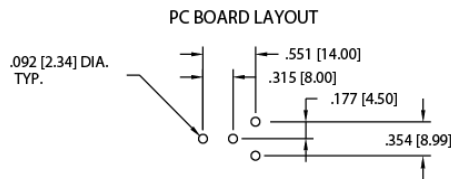

Dimensions inches [mm]

### DZ82AB-5-PCB - 5 Pin PCB socket for micro-ISO relays



- Brass, bright tin (Sn) plated contacts
- Heat stabilised thermoplastic, 140°C
- Continuous use temperature rating
- 5 Pin
- PCB Mount
- RoHS Compliant

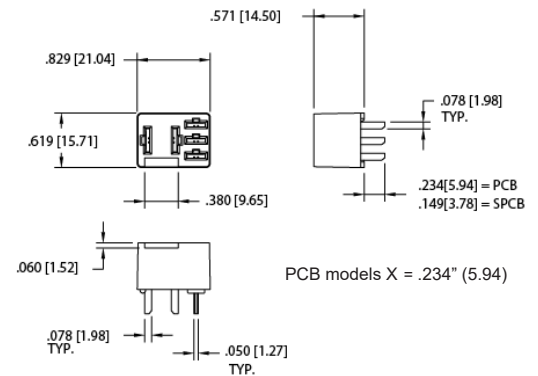
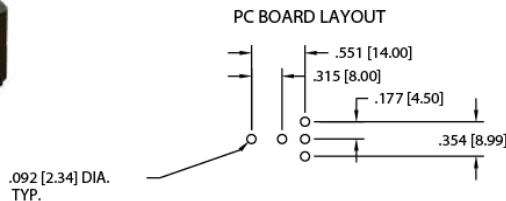

Dimensions inches [mm]

### DZ82AB-4-SPCB - 4 Short pin PCB socket for micro-ISO relays



- Brass, bright tin (Sn) plated contacts
- Heat stabilised thermoplastic, 140°C
- Continuous use temperature rating
- 4 Short pins
- PCB Mount
- RoHS Compliant

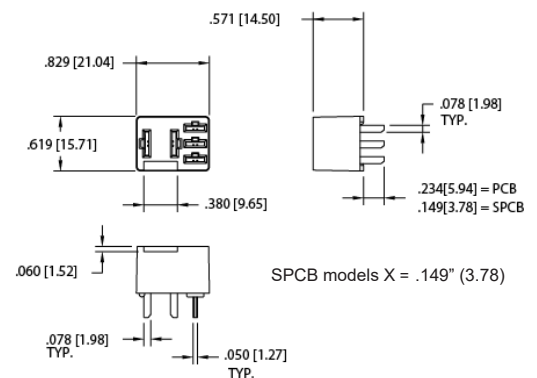
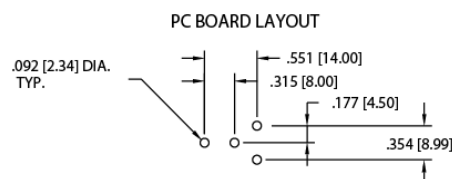

Dimensions inches [mm]



### DZ82AB-5-SPCB - 5 Short pin PCB socket for micro-ISO relays



- Brass, bright tin (Sn) plated contacts
- Heat stabilised thermoplastic, 140°C
- Continuous use temperature rating
- 5 Short pins
- PCB Mount
- RoHS Compliant

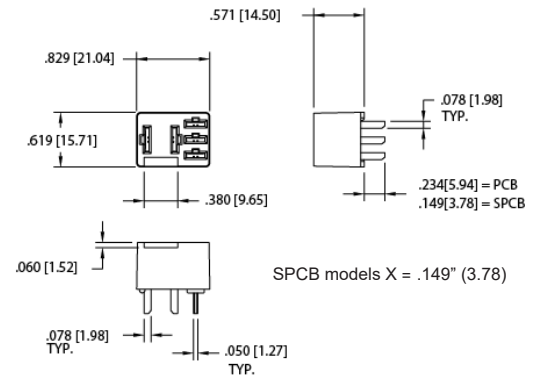
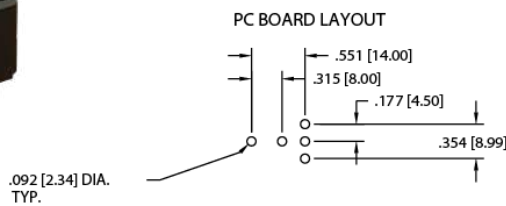

Dimensions inches [mm]

### DZ82AB-5-WH1 - Socket with mounting bracket for micro-ISO relays

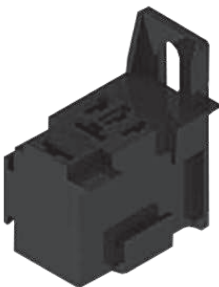

- Heat stabilised thermoplastic, 140°C
- Continuous use temperature rating
- For industry standard terminals - not included
- Typical suitable terminals:
  - ♦ AMP 42100 1/4" blade 14-18 AWG
  - ♦ AMP 42281 1/4" blade 14-18 AWG
  - ♦ AMP 42904 1/4" blade 12-16 AWG
  - ♦ AMP 60249 1/4" blade 12-16 AWG
  - ♦ AMP 60253 1/4" blade 12-14 AWG
  - ♦ AMP 281197 3/16" blade 13-17 AWG
  - ♦ AMP 282180 3/16" blade 15-20 AWG
- 5 Pin housing
- Crimp not supplied
- RoHS Compliant

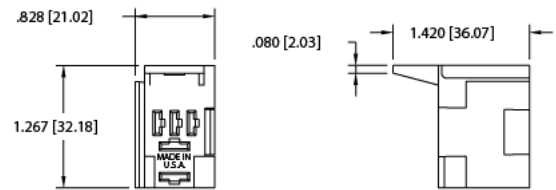

Dimensions inches [mm]

### DZ82AB-5-WH2 - Socket with mounting bracket for micro-ISO relays

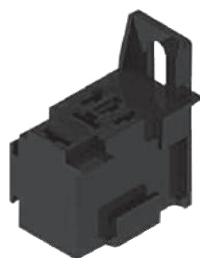

- Heat stabilised thermoplastic, 140°C
- Continuous use temperature rating
- For industry standard terminals - not included
- Typical suitable terminals:
  - ♦ AMP 42100 1/4" blade 14-18 AWG
  - ♦ AMP 42281 1/4" blade 14-18 AWG
  - ♦ AMP 42904 1/4" blade 12-16 AWG
  - ♦ AMP 60249 1/4" blade 12-16 AWG
  - ♦ AMP 60253 1/4" blade 12-14 AWG
  - ♦ AMP 281197 3/16" blade 13-17 AWG
  - ♦ AMP 282180 3/16" blade 15-20 AWG
- 5 Pin housing
- Crimp not supplied
- RoHS Compliant

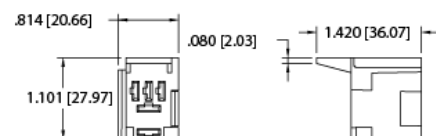

Dimensions inches [mm]

### DZ85AB-4-WH - 4 Pin cable housing socket without mounting bracket for mini-ISO relays



- Heat stabilised thermoplastic, 140°C
- Continuous use temperature rating
- For industry standard terminals - not included
- Typical suitable terminals:
  - ◆ AMP 42100 ¼" blade 14-18 AWG
  - ◆ AMP 42281 ¼" blade 14-18 AWG
  - ◆ AMP 42904 ¼" blade 12-16 AWG
  - ◆ AMP 60249 ¼" blade 12-16 AWG
  - ◆ AMP 60253 ¼" blade 12-14 AWG
- RoHS Compliant

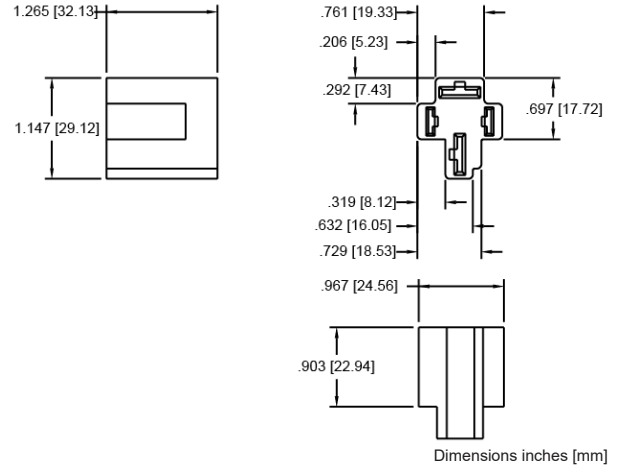

### DZ85AB-5-WH - 5 Pin cable housing socket without mounting bracket for mini-ISO relays



- Heat stabilised thermoplastic, 140°C
- Continuous use temperature rating
- For industry standard terminals - not included
- Typical suitable terminals:
  - ◆ AMP 42100 ¼" blade 14-18 AWG
  - ◆ AMP 42281 ¼" blade 14-18 AWG
  - ◆ AMP 42904 ¼" blade 12-16 AWG
  - ◆ AMP 60249 ¼" blade 12-16 AWG
  - ◆ AMP 60253 ¼" blade 12-14 AWG
- RoHS Compliant

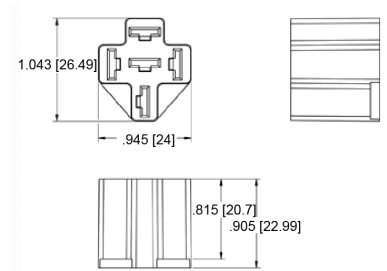

### DZ85AB-5-WH1 - 5 Pin cable housing sockets for relays or flashers



- Heat stabilised thermoplastic, 140°C
- For industry standard terminals - not included
- Typical suitable terminals:
  - ◆ AMP 42100 ¼" blade 14-18 AWG
  - ◆ AMP 42281 ¼" blade 14-18 AWG
  - ◆ AMP 42904 ¼" blade 12-16 AWG
  - ◆ AMP 60249 ¼" blade 12-16 AWG
  - ◆ AMP 60253 ¼" blade 12-14 AWG
- RoHS Compliant

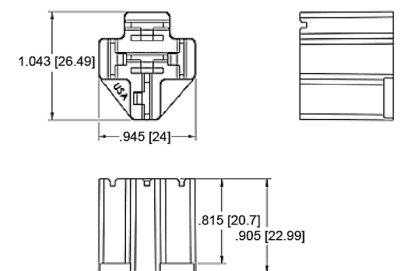

### DZ85AB-5-WH2 - 5 Pin cable housing socket with mounting bracket for mini-ISO relays



- Heat stabilised thermoplastic, 140°C
- Continuous use temperature rating
- Brass, bright tin (Sn) plated contacts
- For industry standard terminals - not included
- Typical suitable terminals:
  - ◆ AMP 42100 ¼" blade 14-18 AWG
  - ◆ AMP 42281 ¼" blade 14-18 AWG
  - ◆ AMP 42904 ¼" blade 12-16 AWG
  - ◆ AMP 60249 ¼" blade 12-16 AWG
  - ◆ AMP 60253 ¼" blade 12-14 AWG
- RoHS Compliant

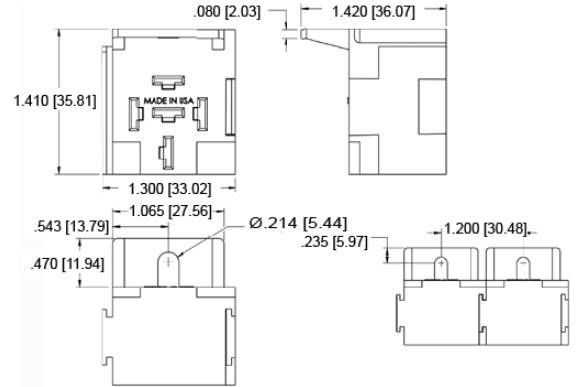

Dimensions inches [mm]

### DZ85AB-4-PCB - 4 Pin PCB socket for mini ISO relays



- Heat stabilised thermoplastic, 140°C
- Continuous use temperature rating
- Brass, bright tin (Sn) plated contacts
- 4 Pin
- RoHS Compliant

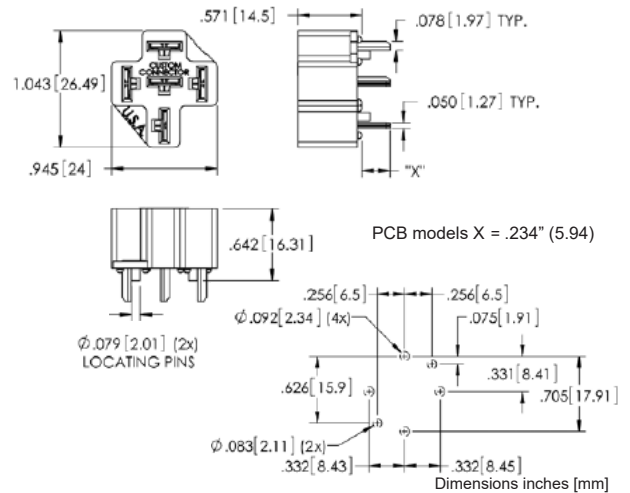

Dimensions inches [mm]

### DZ85AB-4-SPCB - 4 Short pin PCB socket for mini-ISO relays



- Heat stabilised thermoplastic, 140°C
- Continuous use temperature rating
- Brass, bright tin (Sn) plated contacts
- 4 Short pins
- RoHS Compliant

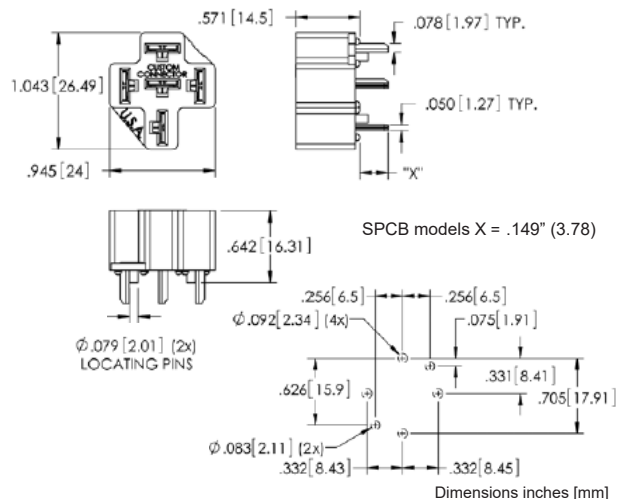

Dimensions inches [mm]

### DZ85AB-5-PCB - 5 Pin PCB socket for mini-ISO relays



- Heat stabilised thermoplastic, 140°C
- Continuous use temperature rating
- For industry standard terminals - not included
- 5 Pin
- RoHS Compliant

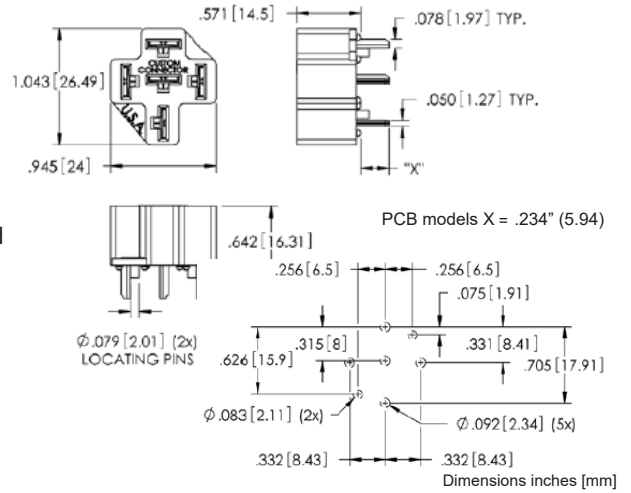

### DZ85AB-5-SPCB - 5 Short pin socket for mini-ISO relays



- Heat stabilised thermoplastic, 140°C
- Continuous use temperature rating
- For industry standard terminals - not included
- 5 Short pins
- RoHS Compliant

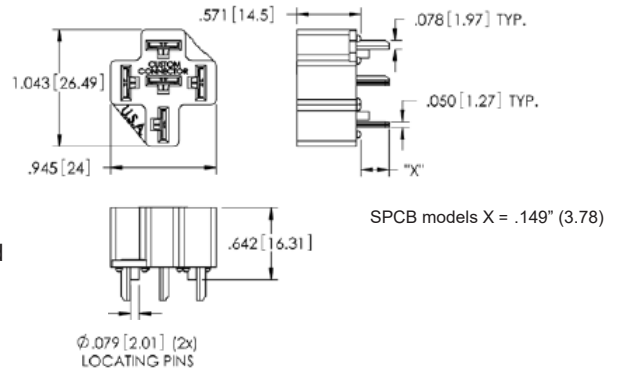

Dimensions inches [mm]

### DZ85CD-4-SPCB - 4 Terminal PCB - 6 Short pin socket for mini-ISO relays



- SPCB Model, Brass, Bright Tin (Sn) Plated Contacts
- Heat stabilised thermoplastic, 140°C
- Continuous use temperature rating
- 6 Short Pins
- RoHS Compliant

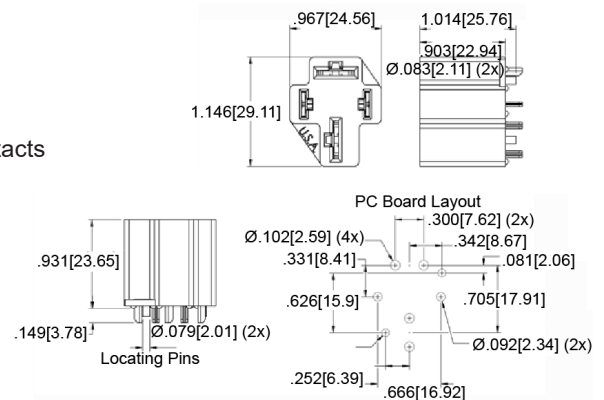

Dimensions inches [mm]



### DZ85CD-4-WH - 4 Terminal cable housing socket for maxi-ISO relays



- Heat stabilised thermoplastic, 140°C
- Continuous use temperature rating
- For industry standard terminals - not included
- Typical suitable crimp terminals:
  - ◆ AMP 42100 ¼" blade 14-18 AWG
  - ◆ AMP 42281 ¼" blade 14-18 AWG
  - ◆ AMP 42904 ¼" blade 12-16 AWG
  - ◆ AMP 60249 ¼" blade 12-16 AWG
  - ◆ AMP 60253 ¼" blade 12-14 AWG
  - ◆ AMP 280756 ⅜" blade 10-12 AWG
- RoHS Compliant

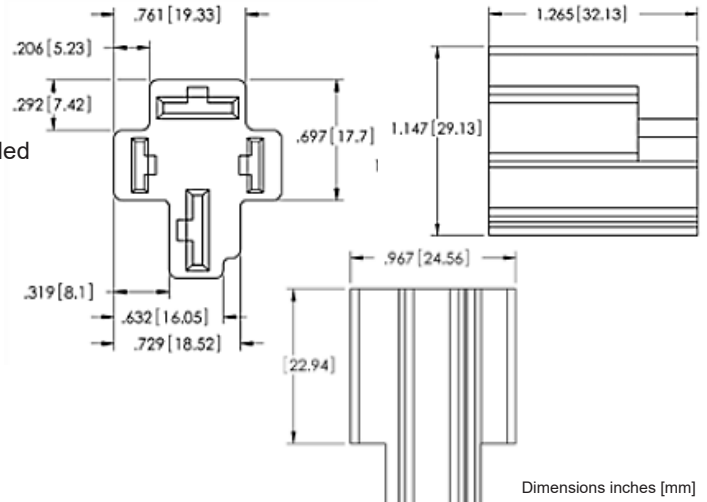

### DZ85CD-5-WH - 5 Terminal cable housing socket for maxi-ISO relays



- Heat stabilised thermoplastic, 140°C
- Continuous use temperature rating
- For industry standard terminals - not included
- Typical suitable crimp terminals:
  - ◆ AMP 42100 ¼" blade 14-18 AWG
  - ◆ AMP 42281 ¼" blade 14-18 AWG
  - ◆ AMP 42904 ¼" blade 12-16 AWG
  - ◆ AMP 60249 ¼" blade 12-16 AWG
  - ◆ AMP 60253 ¼" blade 12-14 AWG
  - ◆ AMP 280756 ⅜" blade 10-12 AWG
- RoHS Compliant

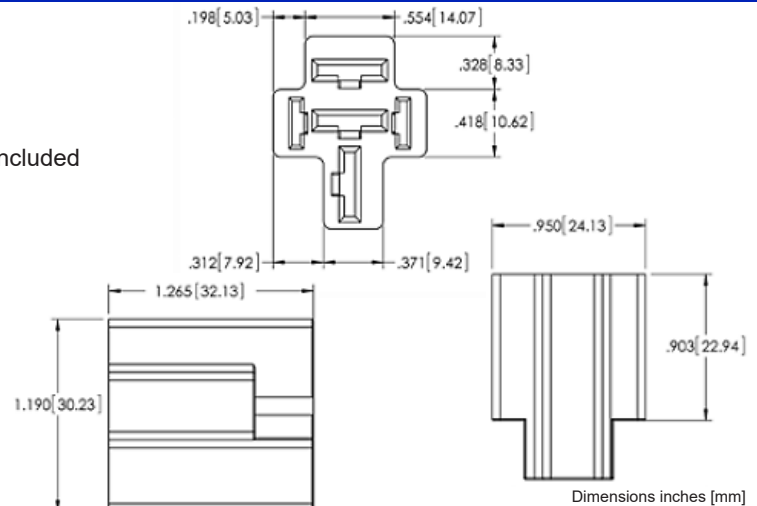

### DZ85AB-5-WP Weatherproof socket for mini-ISO relays



- Heat stabilised thermoplastic, 140°C
- Continuous use temperature rating
- For industry standard terminals - not included
- Typical suitable crimp terminals:
  - ◆ AMP 42100 ¼" blade 14-18 AWG
  - ◆ AMP 60253 ¼" blade 12-14 AWG
- RoHS Compliant
- IP67
- Testing passed:
  - ◆ Dust Exposure: SAE J1455 Sect. 4.7, IEC 60529 Sect. 13.4 & 13.6
  - ◆ Salt Spray: ASTM B117-07
  - ◆ Water Immersion IEC 60529 Sect. 14.2.7
  - ◆ Fluids Compatibility SAE J1455 Sect. 4.7, Engine Oil, Brake Fluid, Washer Solvent, Gasoline, Diesel Fuel

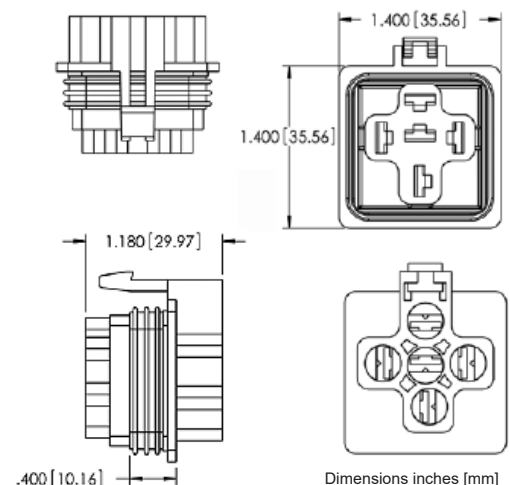

High temperature silicone gasket wire seals for weatherproof mini-ISO Socket DZAB-5-WP



Part No.	X	Y	Z	Colour
DZ85S-O	0.060	0.150	0.429	Orange
DZ85S-G	0.090	0.190	0.396	Grey
DZ85S-Y	0.130	0.230	0.376	Yellow
DZ85P-G	N/A	N/A	0.353	Grey

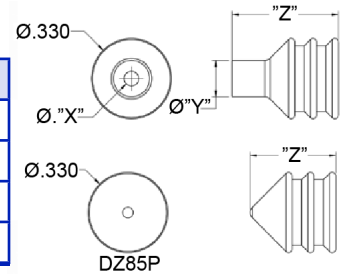

Dimensions inches

The logo for Durakool, featuring the brand name in a bold, italicized, sans-serif font. The 'D' is stylized with a horizontal bar extending to the left. The background of the entire page is a dynamic, abstract blue and white graphic with flowing, ribbon-like shapes that create a sense of motion and depth.

**DURAKOOL**

— A WT/AEC Brand —