

# Part No: A1-009 - A1 Series Tilt Switch - Mercury

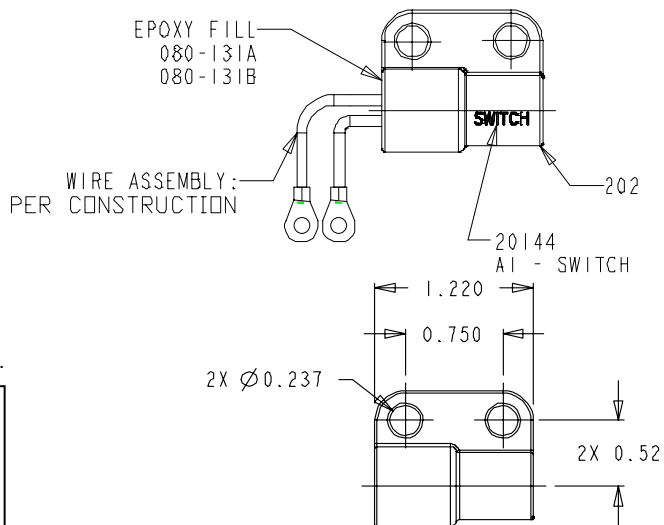

- Features:**
- \* Insulated
  - \* Form: NO/NC/SPST/Mount dependant
  - \* Angles Referenced from Horizontal
  - \* Single Electrode
  - \* Hermetically Sealed
  - \* Small Package Size
  - \* Extremely Narrow Included Angle
  - \* High Current Capability
  - \* Low Contact Resistance
  - \* Long Life



Drawing dimensions in inches.

Tilt switches "make" when the electrode is tilted below horizontal and "break" when tilted above the horizontal. Total travel from "make" to "break" is the "Maximum included angle" shown below. The component to which the switch is attached must have a total tilt angle greater than the "Maximum included angle" for proper operation.

Must Break Angle * :	+ 0.7°
Maximum included Angle:	1.4°
	* Make/break angles are electrode + (above) / - (below) 0° horizontal reference
<b>Switch Ratings:</b>	
Max Switching Voltage	120V 60Hz
Max Switching Current	1 Amp max @ 120VAC, 1 million operations
Initial Contact Resistance (Max).	50 milli Ohms
Stand Off Voltage (contact to contact)	1500 VAC
Operating Temperature	-38° to 220°F / -38° to 105°C
Storage Temperature	-40° to 356°F / -40° to 180° C
Typical number of operations at specified load	10,000,000
G-Force Activation G-Level/Range	N/A
<b>Dimensions:</b>	
Weight per 100pcs. Lbs / Kgs:	
Body Length (less leads). Inches / Millimeters:	1.220 / 31.0
Maximum width over bracket. Inches / Millimeters:	1.07 / 27.18
<b>Materials:</b>	
Lead Wire Type	# 18AWG silicon grey
Lead wire length/skive/termination	6" / ring terminals
Finish:	Nylon 6/12 (33% glass filled)



© American Electronic Components Inc 2012

**American Electronic Components Inc.,**  
 1101 Lafayette Street, Elkhart, Indiana. USA  
 Tel: +1-574-295-6330 Fax: +1-574-293-8013  
 Email: [sales@aecensors.com](mailto:sales@aecensors.com)  
<http://www.aecensors.com>